

# CATÁLOGO TÉCNICO HERRAMIENTA MANUAL



[www.importadorasuperior.com/](http://www.importadorasuperior.com/)

Calle 15 No. 19 A - 01

(57 1) 351 55 10

[info@impsuperior.com](mailto:info@impsuperior.com)



# CROMO

# VANADIO

## *¿Qué es?*

*El cromo vanadio es un elemento químico (METAL) formado por el cromo (Cr) y el vanadio (V) su principal característica es su estructura fuerte ya que el nivel de cromo esta entre 0,80 y 1,10 %, y el contenido de vanadio es de aproximadamente 0,18 % la fusión de estos dos elementos hace que mejore sus características de manera óptima obteniendo el cromo-vanadio, metal que se caracteriza por su resistencia*

*El cromo es un metal de transición duro, frágil, color blanco agrisado y brillante. Es muy resistente frente a la corrosión.*

## RATCHET

Un trinquete es un mecanismo que permite a un engranaje girar hacia un lado, pero le impide hacerlo en sentido contrario, ya que lo traba con un gatillo que engrana en los dientes en forma de sierra. Permite que los mecanismos no giren en el sentido contrario al deseado.

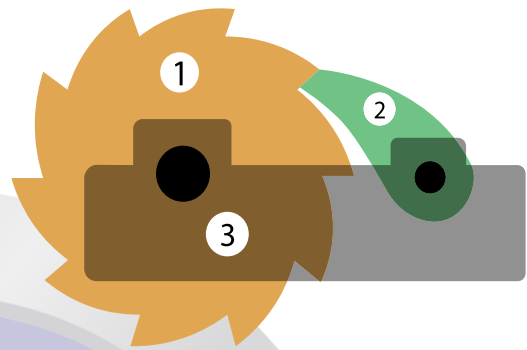

## LLAVES

Las llaves de apriete son las herramientas manuales que se utilizan para apretar elementos atornillados mediante tornillos o tuercas con cabezas principalmente hexagonales. En las industrias o grandes producciones estas llaves son sustituidas por pistolas neumáticas o por atornilladoras.

### TIPOS DE LLAVES

#### LLAVE MIXTA

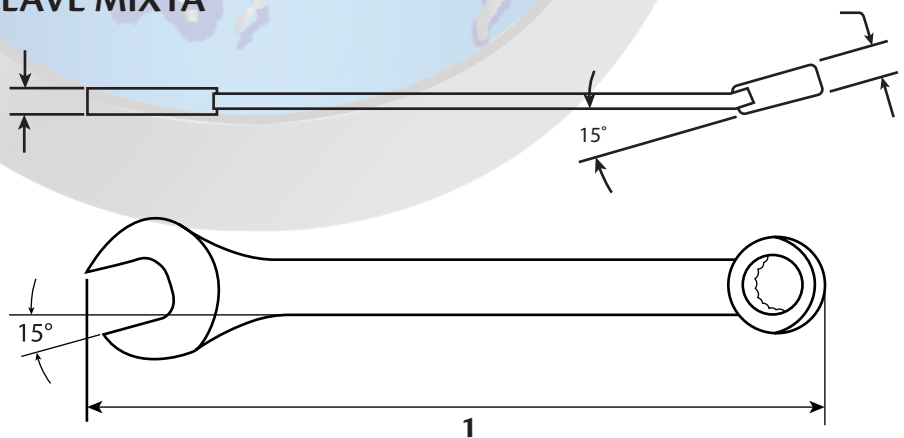

1. Acero cromo-vanadio de alta resistencia.

Todas tienen acabado cromado.

Cuentan con perfil ergonómico con acceso a lugares estrechos.

### LLAVE BOCA FIJA

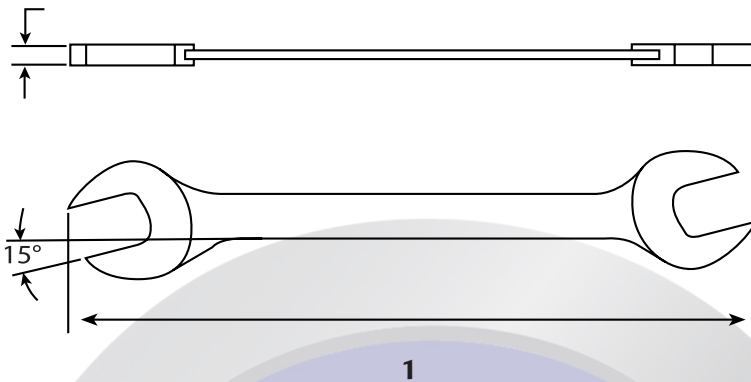

### LLAVE MIXTA CON RATCHET

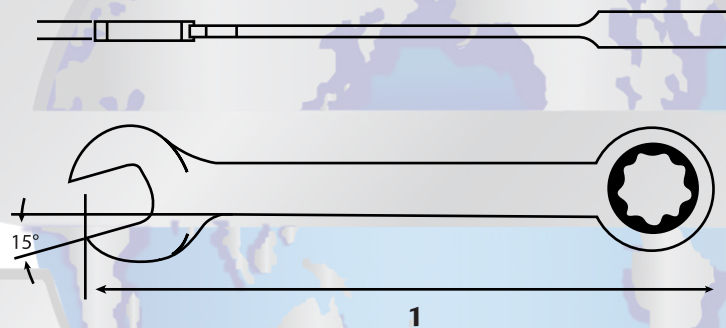

### LLAVE ESTRELLA

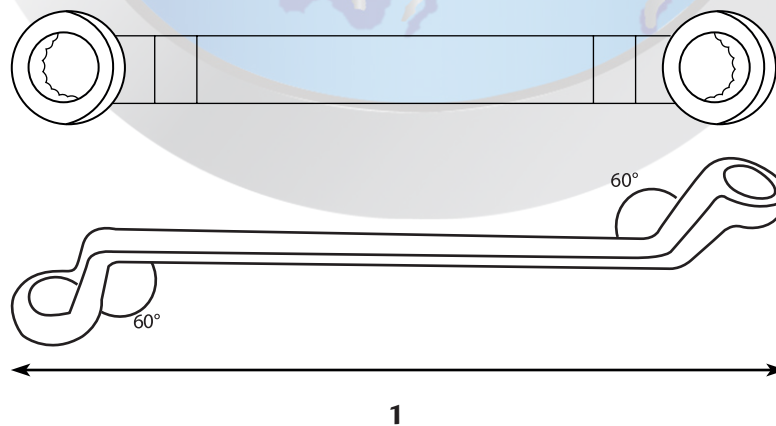

1. Acero cromo-vanadio de alta resistencia.  
 Todas tienen acabado cromado.  
 Cuentan con perfil ergonómico con acceso a lugares estrechos.

**LEC**  
**Llave Estrella**

**Medida**  
**mm**



*Pulido espejo para  
fácil limpieza*



Código	Medida	Uni
LEC67	6 mm X 7 mm	50
LEC89	8 mm x 9 mm	25
LEC1011	10 mm x 11 mm	25
LEC1213	12 mm x 13 mm	20
LEC1415	14 mm x 15 mm	20
LEC1617	16 mm x 17 mm	20
LEC1819	18 mm x 19 mm	20
LEC2022	20 mm x 22 mm	10

Código	Medida	Uni
LBFC67	6 mm x 7 mm	100
LBFC89	8 mm x 9 mm	100
LBFC1011	10 mm x 11 mm	50
LBFC1213	12 mm x 13 mm	50
LBFC1415	14 mm x 15 mm	25
LBFC1617	16 mm x 17 mm	25
LBFC1819	18 mm x 19 mm	20
LBFC2022	20 mm x 22 mm	20
LBFC2123	21 mm x 23 mm	20
LBFC2426	24 mm x 26 mm	20

**LMC**  
**Llave Mixta**

**Medida**  
**mm**



*Pulido espejo para  
fácil limpieza*



Código	Medida	Uni	Código	Medida	Uni
LMC6	6 mm	50	LMC17	17 mm	20
LMC7	7 mm	50	LMC18	18 mm	20
LMC8	8 mm	50	LMC19	19 mm	20
LMC9	9 mm	50	LMC20	20 mm	20
LMC10	10 mm	50	LMC21	21 mm	20
LMC11	11 mm	50	LMC22	22 mm	20
LMC12	12 mm	50	LMC23	23 mm	10
LMC13	13 mm	25	LMC24	24 mm	10
LMC14	14 mm	25	LMC27	27 mm	10
LMC15	15 mm	25	LMC30	30 mm	10
LMC16	16 mm	20	LMC32	32 mm	10

**LBCF**  
**Llave Boca Fija**

**Medida**  
**mm**



*Pulido espejo para  
fácil limpieza*

### LMCP Llave Mixta

Medida  
In



*Pulido espejo para fácil limpieza*

Código	Medida	Uni	Código	Medida	Uni
LMCP14	1/4"	100	LMCP1516	15/16"	1
LMCP516	5/16"	100	LMCP1	1"	5
LMCP38	3/8"	25	LMCP116	1 1/16"	5
LMCP716	7/16"	50	LMCP118	1 1/8"	5
LMCP12	1/2"	25	LMCP114	1 1/4"	5
LMCP916	9/16"	25	LMCP1-516	1-5/16"	5
LMCP58	5/8"	25	LMCP138	1-3/8"	5
LMCP1116	1 1/16"	20	LMCP112	1-1/2"	5
LMCP34	3/4"	20	LMCP158	1-5/8"	5
LMCP1316	13/16"	20	LMCP134	1-3/4"	5
LMCP78	7/8"	50	LMCP178	1-7/8"	5

### JMC Juego de Llaves Mixtas

Medida  
In - mm



*Pulido espejo para fácil limpieza*



Código	Medida	Uni
JMC817	6 Pcs - CrVan 8-17 mm	1
JMC819	8 pcs / 8-19mm	1

### JBFC622 Juego de Llaves Boca Fija

Medida  
In



*Pulido espejo para fácil limpieza*

Código	Medida	Uni
JBFC622	Juego Llaves 8 Pcs Superior Boca Fija CrVan 6-22 mm	1

### JMCP / JMC Juego de Llaves Mixtas

Medida  
In - mm



*Pulido espejo para fácil limpieza*



Código	Medida	Uni
JMCP381	11 Pcs - 3/8" - 1"	1
JMC724	14 Pcs / 7-24 mm	1
JMCP38114	14 Pcs / 3/8"-1-1/4"	1
JMC1032	14 Pcs / 10 - 32 mm	1
JMC832	18 Pcs / 8-32 mm	1
JMC824	9 Pcs - 8-24 mm	1
JMCP3878	8 Pcs / 3/8"-7/8"	1

**JEC622**  
**Juego de Llaves Estrella fija**

**Medida**  
mm

Pulido espejo para fácil limpieza

12 Puntas

Código	Medida	Uni
JEC622	Juego Llaves 6 Pcs Estrella CrVan 6-22 mm	1

**JBFC617**  
**Juego de Llaves Boca Fija**

**Medida**  
mm

Pulido espejo para fácil limpieza

Código	Medida	Uni
JBFC617	Juego Llaves 6 Pcs Boca Fija CrVan 6-17 mm	1

**C12CM**  
**Copa 12 Pts**

**Medida**  
In - mm

Pulido espejo para fácil limpieza

12 Puntas

Cuadrante

1/2"

Código	Medida	U.	Código	Medida	U.
C12CM128	1/2" X 8 mm	5	C12CM1218	1/2" X 18 mm	5
C12CM129	1/2" X 9 mm	5	C12CM1219	1/2" X 19 mm	5
C12CM1210	1/2" X 10 mm	5	C12CM1220	1/2" X 20 mm	5
C12CM1211	1/2" X 11 mm	5	C12CM1221	1/2" X 21 mm	5
C12CM1212	1/2" X 12 mm	5	C12CM1222	1/2" X 22 mm	5
C12CM1213	1/2" X 13 mm	5	C12CM1223	1/2" X 23 mm	5
C12CM1214	1/2" X 14 mm	5	C12CM1224	1/2" X 24 mm	5
C12CM1215	1/2" X 15 mm	5	C12CM1227	1/2" X 27 mm	5
C12CM1216	1/2" X 16 mm	5	C12CM1230	1/2" X 30 mm	5
C12CM1217	1/2" X 17 mm	5	C12CM1232	1/2" X 32 mm	5

**C6CM**  
**Copa 6 Puntas Cr Van**

Medida  
In - mm

Cuadrantes:

**1/4"**

**3/8"**



Pulido espejo para  
fácil limpieza

Código	Medida	U.	Código	Medida	U.
C6CM144	1/4" X 4 mm	5	C6CP141532	1/4" X 15/32"	5
C6CM145	1/4" X 5 mm	5	C6CP1412	1/4" X 1/2"	5
C6CM146	1/4" X 6 mm	5	C6CP14916	1/4" X 9/16"	5
C6CM147	1/4" X 7 mm	5	C6CM386	3/8" X 6 mm	5
C6CM148	1/4" X 8 mm	5	C6CM387	3/8" X 7 mm	5
C6CM149	1/4" X 9 mm	5	C6CM388	3/8" X 8 mm	5
C6CM1410	1/4" X 10 mm	5	C6CM389	3/8" X 9 mm	5
C6CM1411	1/4" X 11 mm	5	C6CM3810	3/8" X 10 mm	5
C6CM1412	1/4" X 12 mm	5	C6CM3811	3/8" X 11 mm	5
C6CM1413	1/4" X 13 mm	5	C6CM3812	3/8" X 12 mm	5
C6CM1414	1/4" X 14 mm	5	C6CM3813	3/8" X 13 mm	5
C6CP14316	1/4" X 3/16"	5	C6CM3814	3/8" X 14 mm	5
C6CP1414	1/4" X 1/4"	5	C6CM3815	3/8" X 15 mm	5
C6CP14516	1/4" X 5/16"	5	C6CM3816	3/8" X 16 mm	5
C6CP141132	1/4" X 11/32"	5	C6CM3817	3/8" X 17 mm	5
C6CP1438	1/4" X 3/8"	5	C6CM3818	3/8" X 18 mm	5
			C6CM3819	3/8" X 19 mm	5
C6CP141332	1/4" X 13/32"	5	C6CM3820	3/8" X 20 mm	5
			C6CM3821	3/8" X 21 mm	5
C6CP14716	1/4" X 7/16"	5	C6CM3822	3/8" X 22 mm	5
			C6CM3824	3/8" X 24 mm	5



**C6CP / C6CM**  
**Copa 6 Pts CR VAN**

**Medida**  
**In - mm**



Cuadrantes:

**3/8"**

**1/2"**

<b>Código.</b>	<b>Medida</b>	<b>Uni</b>	<b>Código.</b>	<b>Medida</b>	<b>Uni</b>
C6CP3814	3/8" X 1/4"	5	C6CM1219	1/2" X 19 mm	5
C6CP38516	3/8" X 5/16"	5	C6CM1220	1/2" X 20 mm	5
C6CP3838	3/8" X 3/8"	5	C6CM1221	1/2" X 21 mm	5
C6CP38716	3/8" X 7/16"	5	C6CM1222	1/2" X 22 mm	5
C6CP3812	3/8" X 1/2"	5	C6CM1223	1/2" X 23 mm	5
C6CP38916	3/8" X 9/16"	5	C6CM1224	1/2" X 24 mm	5
C6CP3858	3/8" X 5/8"	5	C6CM1227	1/2" X 27 mm	5
C6CP381116	3/8" X 11/16"	5	C6CM1234	1/2" X 34 mm	5
C6CP3834	3/8" X 3/4"	5	C6CM1236	1/2" X 36 mm	5
C6CP381316	3/8" X 13/16"	5	C6CP12716	1/2" X 7/16"	5
C6CP3878	3/8" X 7/8"	5	C6CP1212	1/2" X 1/2"	5
C6CM1210	1/2" X 10 mm	5	C6CP12916	1/2" X 9/16"	5
C6CM1211	1/2" X 11 mm	5	C6CP1258	1/2" X 5/8"	5
C6CM1212	1/2" X 12 mm	5	C6CP121116	1/2" X 11/16"	5
C6CM1213	1/2" X 13 mm	5	C6CP1234	1/2" X 3/4"	5
C6CM1214	1/2" X 145 mm	5	C6CP121316	1/2" X 13/16"	5
C6CM1215	1/2" X 155 mm	5	C6CP1278	1/2" X 7/8"	5
C6CM1216	1/2" X 165 mm	5	C6CP121516	1/2" X 15/16"	5
C6CM1217	1/2" X 17 mm	5	C6CP121	1/2" X 1"	5
			C6CM1218	1/2" X 18 mm	5

## C6CML / C6CPL Copa Larga 6 Pts CR VAN

Medida  
In - mm



Pulido espejo para  
fácil limpieza



Cuadrantes:

$\frac{3}{8}$ "

$\frac{1}{2}$ "

Cód.	Medida	Uni	Cód.	Medida	Uni
C6CML386	3/8" X 6 mm	5	C6CML1210	1/2" X 10 mm	5
C6CML387	3/8" X 7 mm	5	C6CML1211	1/2" X 11 mm	5
C6CML388	3/8" X 8 mm	5	C6CML1212	1/2" X 12 mm	5
C6CML389	3/8" X 9 mm	5	C6CML1213	1/2" X 13 mm	5
C6CML3810	3/8" X 10 mm	5	C6CML1214	1/2" X 14 mm	5
C6CML3811	3/8" X 11 mm	5	C6CML1215	1/2" X 15 mm	5
C6CML3812	3/8" X 12 mm	5	C6CML1216	1/2" X 16 mm	5
C6CML3813	3/8" X 13 mm	5	C6CML1217	1/2" X 17 mm	5
C6CML3814	3/8" X 14 mm	5	C6CML1218	1/2" X 18 mm	5
C6CML3815	3/8" X 15 mm	5	C6CML1219	1/2" X 19 mm	5
C6CML3816	3/8" X 16 mm	5	C6CML1220	1/2" X 20 mm	5
C6CML3817	3/8" X 17 mm	5	C6CML1221	1/2" X 21 mm	5
C6CML3818	3/8" X 18 mm	5	C6CML1222	1/2" X 22 mm	5
C6CML3819	3/8" X 19 mm	5	C6CML1223	1/2" X 23 mm	5
C6CML3820	3/8" X 20 mm	5	C6CML1224	1/2" X 24 mm	5
C6CPL3814	3/8" X 1/4"	5	C6CPL12716	1/2" X 7/16"	5
C6CPL38516	3/8" X 5/16"	5	C6CPL1212	1/2" X 1/2"	5
C6CPL3838	3/8" X 3/8"	5	C6CPL12916	1/2" X 9/16"	5
C6CPL38716	3/8" X 7/16"	5	C6CPL1258	1/2" X 5/8"	5
C6CPL3812	3/8" X 1/2"	5	C6CPL121116	1/2" X 11/16"	5
C6CPL38916	3/8" X 9/16"	5	C6CPL1234	1/2" X 3/4"	5
C6CPL3858	3/8" X 5/8"	5	C6CPL121316	1/2" X 13/16"	5
C6CPL381116	3/8" X 11/16"	5	C6CPL1278	1/2" X 7/8"	5
C6CPL3834	3/8" X 3/4"	5	C6CPL121516	1/2" X 15/16"	5
C6CPL381316	3/8" X 13/16"	5	C6CPL121	1/2" X 1"	5
C6CPL3878	3/8" X 7/8"	5	C6CPL12114	1/2" X 1-1/4"	5
C6CML1410	1/4" X 10 mm	5	C6CML148	1/4 X 8 mm	5

**LMRCP / LMRC6**  
**Llave mixta T/Ratchet CR VAN**

**Medida**  
**In - mm**



Cód	Descripción	Unidad E.
LMRCP14	1/4"	400
LMRCP516	5/16"	400
LMRCP38	3/8"	300
LMRCP716	7/16"	240
LMRCP12	1/2"	210
LMRCP916	9/16"	150
LMRCP58	5/8"	120
LMRCP1116	11/16"	120
LMRCP34	3/4"	100
LMRCP1316	13/16"	60
LMRCP78	7/8"	60
LMRCP1516	15/16"	45
LMRCP1	1"	45

Cód.	Medida	Uni E.
LMRC6	6mm	400
LMRC7	7mm	400
LMRC8	8mm	400
LMRC9	9mm	300
LMRC10	10mm	300
LMRC11	11mm	240
LMRC12	12mm	240
LMRC13	13mm	210
LMRC14	14mm	150
LMRC15	15mm	150
LMRC16	16mm	120
LMRC17	17mm	120
LMRC18	18mm	100
LMRC19	19mm	100
LMRC20	20mm	90
LMRC21	21mm	60
LMRC22	22mm	60
LMRC23	23mm	45
LMRC24	24mm	45

**PLC12**  
**Palanca P/copa CR VAN**

**Medida**  
**In**



Cód	Descripción	Unidad E.
PLC12	1/2" x 10"	1

**CPTM**  
**Copa P/Taladro Magnética CR VAN**

**Medida**  
**In**



Cód	Descripción	Unidad E.
CPTM516	5/16"	1
CPTM38	3/8"	1

**LMCCP**  
**LLAVE MIXTA CORTA**  
**SUPERIOR CR VAN**

Medida  
In - mm



Cód.	Descripción	Unidad E.
LMCCP716	7/16"	40
LMCCP12	1/2"	30
LMCCP916	9/16"	20
LMCCP58	5/8"	20
LMCCP1116	11/16"	150
LMCCP34	3/4"	10

**LFKAN4**  
**Llave para Filtro de Aceite**

Medida  
In



Código	Uni. E
LFKAN4	60

**LMCC**  
**Llave Mixta Corta CR VAN**

Medida  
In - mm



Cód.	Descripción	Unidad E
LMCC9	9mm	400
LMCC10	10mm	400
LMCC11	11mm	375
LMCC12	12mm	375
LMCC13	13mm	290
LMCC14	14mm	200
LMCC15	15mm	200
LMCC16	16mm	200
LMCC17	17mm	100
LMCC18	18mm	150
LMCC19	19mm	100

**MCS12**  
**Mango Corredizo P/copa**  
**CR VAN**

Medida  
In

Cuadrante

3/8"

1/2"



Código	Descripción	Uni. E
MCS38	Cuadrante 3/8"	1
MCS12	Cuadrante 1/2"	1

### C12CM Copa 12 Pts CR VAN

Medida  
In - mm



Cuadrante  
**1/2"**

Cód.	Medida	U	Cód.	Medida	U
C12CM128	1/2" X 8 mm	5	C12CM1218	1/2" X 18 mm	5
C12CM129	1/2" X 9 mm	5	C12CM1219	1/2" X 19 mm	5
C12CM1210	1/2" X 10 mm	5	C12CM1220	1/2" X 20 mm	5
C12CM1211	1/2" X 11 mm	5	C12CM1221	1/2" X 21 mm	5
C12CM1212	1/2" X 12 mm	5	C12CM1222	1/2" X 22 mm	5
C12CM1213	1/2" X 13 mm	5	C12CM1223	1/2" X 23 mm	5
C12CM1214	1/2" X 14 mm	5	C12CM1224	1/2" X 24 mm	5
C12CM1215	1/2" X 15 mm	5	C12CM1227	1/2" X 27 mm	5
C12CM1216	1/2" X 16 mm	5	C12CM1230	1/2" X 30 mm	5
C12CM1217	1/2" X 17 mm	5	C12CM1232	1/2" X 32 mm	5

### UNSUP Unión Universal

Pulgada  
In



Cuadrante

**3/8"**

**1/2"**

Código.	Medida	Unidad
UNSUP38	3/8"	5
UNSUP12	1/2"	5

### EXSUP Extensión CR Van

Medida  
In



Cuadrante

**3/8"**

**1/2"**

Cód.	Medida	Uni. E.
EXSUP383	3/8" X 3"	5
EXSUP385	3/8" X 5"	5
EXSUP3810	3/8" X 10"	5
EXSUP123	1/2" X 3"	5
EXSUP125	1/2" X 5"	5
EXSUP1210	1/2" X 10"	5

### CBSP / CBSM Copa Para Bujía CR Van

Medida  
In - mm



Cuadrante

**3/8"**

**1/2"**

Código	Medida	Uni E
CBSP381316	3/8" X 3/16"	5
CBSP3858	3/8" X 5/8"	5
CBSP121316	1/2" X 13/16"	5
CBSP1258	1/2" X 5/8"	5
CBSM3816	3/8" x 16 mm	5
CBSM1216	1/2" X 16mm	5
CBSM1221	1/2" x 21 mm	5
CBSM3821	3/8" x 21 mm	5

### C6CM / C6CP Copa 6PTS corta CR Van



Medidas  
In - mm

Cuadrante

1/4"

3/8"

1/2"

**Cód.** **Medida** **Uni. E**

C6CM148	1/4" X 8 mm	5
C6CM3814	3/8" X 14 mm	5
C6CM3820	3/8" X 20 mm	5
C6CM1217	1/2" X 17 mm	5
C6CM1218	1/2" X 18 mm	5
C6CM1222	1/2" X 22 mm	5
C6CM1224	1/2" X 24 mm	5
C6CP121316	1/2" X 13/16"	5

### C12CML / C12CPL Copa 12PTS larga CR Van



Medidas  
In - mm

Cuadrante

1/2"

**Cód.** **Medida** **Uni. E.**

C12CML1218	1/2" X 18 mm	5
C12CML1224	1/2" X 24 mm	5
C12CML1210	1/2" X 10 mm	5
C12CML1211	1/2" X 11 mm	5
C12CML1212	1/2" X 12 mm	5
C12CML1213	1/2" X 13 mm	5
C12CML1214	1/2" X 14 mm	5
C12CML1215	1/2" X 15 mm	5
C12CML1216	1/2" X 16 mm	5
C12CML1217	1/2" X 17 mm	5
C12CML1218	1/2" X 18 mm	5
C12CML1219	1/2" X 19 mm	5
C12CML1220	1/2" X 20 mm	5
C12CML1221	1/2" X 21 mm	5
C12CML1222	1/2" X 22 mm	5
C12CML1223	1/2" X 23 mm	5
C12CML1224	1/2" X 24 mm	5
C12CPL12716	1/2" X 7/16"	5
C12CPL1212	1/2" X 1/2"	5
C12CPL12916	1/2" X 9/16"	5
C12CPL1258	1/2" X 5/8"	5
C12CPL121116	1/2" X 11/16"	5
C12CPL1234	1/2" X 3/4"	5
C12CPL121316	1/2" X 13/16"	5
C12CPL1278	1/2" X 7/8"	5
C12CPL121516	1/2" X 15/16"	5

### C6CML Copa 6PTS Larga CR Van



Medida  
In - mm

Cuadrante

1/2"

**Cod** **Medida** **Uni. E**

C6CML1216	1/2" X 16 mm	5
C6CML1217	1/2" X 17 mm	5
C6CML1218	1/2" X 18 mm	5
C6CML1219	1/2" X 19 mm	5
C6CML1221	1/2" X 21 mm	5
C6CML1222	1/2" X 22 mm	5
C6CML1224	1/2" X 24 mm	5

### CPBCM Copa Punta Bristol Cr Van

Medidas  
In - mm

Cuadrante

1/2"

3/8"



Código	Descripción	Unidad E.
--------	-------------	-----------

CPBCM126	1/2" x 6mm	1
CPBCM127	1/2" x 7mm	1
CPBCM128	1/2" x 8mm	1
CPBCM1210	1/2" x 10mm	1
CPBCM1212	1/2" x 12mm	1
CPBCM386	3/8" x 6mm	1
CPBCM387	3/8" x 7mm	1
CPBCM388	3/8" x 8mm	1
CPBCM3810	3/8" x 10mm	1
CPBCM3812	3/8" x 12mm	1

### CPBCML Copa Larga Punta Bristol Cr Van

Medidas  
In - mm

Cuadrante

1/2"

3/8"



Código	Descripción	Unidad E.
--------	-------------	-----------

CPBCML1210	1/2" x 10mm	1
CPBCML1212	1/2" x 12mm	1
CPBCML126	1/2" x 6mm	1
CPBCML127	1/2" x 7mm	1
CPBCML3810	3/8" x 10mm	1
CPBCML3812	3/8" x 12mm	1
CPBCML386	3/8" x 6mm	1
CPBCML387	3/8" x 7mm	1
CPBCML388	3/8" x 8mm	1

### CPTCM Copa PTA/Torx CR VAN

Medidas  
In - mm

Código	Descripción	Unidad E.
--------	-------------	-----------

CPTCM1220	1/2" x 20mm	1
CPTCM1225	1/2" x 25mm	1
CPTCM1227	1/2" x 27mm	1
CPTCM1230	1/2" x 30mm	1
CPTCM1240	1/2" x 40mm	1
CPTCM1245	1/2" x 45mm	1
CPTCM1247	1/2" x 47mm	1
CPTCM3825	3/8" x 25mm	1
CPTCM3827	3/8" x 27mm	1
CPTCM3830	3/8" x 30mm	1
CPTCM3840	3/8" x 40mm	1

Cuadrante

1/2"

3/8"



Punta Torx 6 puntas

**JCM1112**  
Juego Copas 11 Pcs

Medida  
mm



**Medida: 12 PTZ C/ 1/2"**

Cuadrante

**1/2"**

Juego de 11  
piezas

**11**  
PCS

Cumple con la  
norma:

**ANSI**

Pulido espejo para  
fácil limpieza

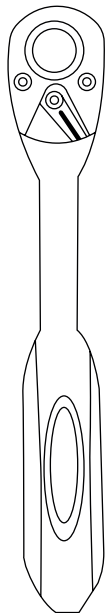

Ratchet Tipo Pera Encauchado 1/2"  
x 1 pcs

Medida: 12 PTZ C/ 1/2"

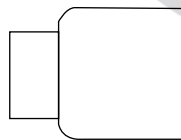

x 10 pcs

Copas Cuad. 1/2"

10 mm	16 mm
11 mm	17 mm
12 mm	19 mm
13 mm	21 mm
14 mm	22 mm

**JCM2112**  
Juego Copas 21 Pcs

Medida  
In mm



**Medida: 6 PTZ C/ 1/2"**

Cuadrante

**1/2"**

Juego de 21  
piezas

**21**  
PCS

Cumple con la  
norma:

**ANSI**

Pulido espejo para  
fácil limpieza

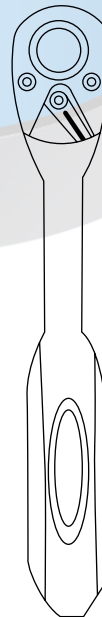

Ratchet Tipo Pera Encauchado 1/2"  
x 1 pcs

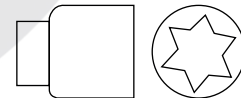

Medida: 6 PTZ C/ 1/2"

Copas Cuad. 1/2"

10 mm	3/8"	x 20 pcs
11 mm	7/16"	
12 mm	1/2"	
13 mm	9/16"	
14 mm	5/8"	
16 mm	11/16"	
17 mm	3/4"	
19 mm	13/16"	
21 mm	7/8"	
22 mm	15/16"	



**JCM1312**  
Juego de Copas 13 pcs

Medida  
mm



**Medida: 12 PTZ C/ 1/2"**

Cuadrante

**1/2"**

Juego de 13  
piezas

**13**  
PCS

Cumple con la  
norma:

**ANSI**

Pulido espejo para  
fácil limpieza

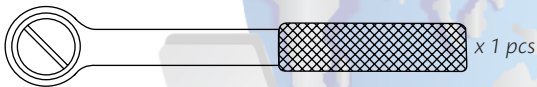

Ratchet Económico de 1/2"

x 1 pcs



Extensión de 1/2" x 5"

x 1 pcs

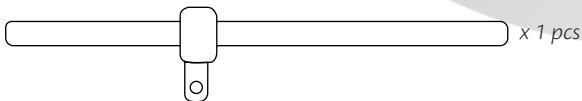

Mango Corredizo P/copa 1/2" x 10"

x 1 pcs

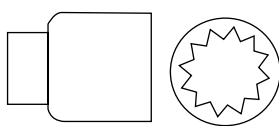

x 10 pcs

Copas Cuad. 1/2"

10 mm	16 mm
11 mm	17 mm
12 mm	19 mm
13 mm	21 mm
14 mm	22 mm

**JCP1712**  
Juego de Copas 17 pcs

Medida  
In



**Medida: 6 PTZ C/ 1/2"**

Cuadrante

**1/2"**

Juego de 17  
piezas

**17**  
PCS

Cumple con la  
norma:

**ANSI**

Pulido espejo para  
fácil limpieza



x 1 pcs

Ratchet Tipo Pera Encauchetado 1/2"



Extensión de 1/2" x 5"

x 1 pcs

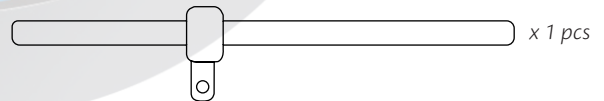

Mango Corredizo P/copa 1/2" x 10"

x 1 pcs

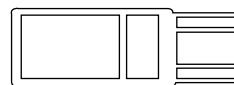

Copa Bujía 13/16"  
x 1 pcs



x 13 pcs

Copas Cuad. 1/2"

5/16"	5/8"
3/8"	11/16"
7/16"	3/4"
15/32"	13/16"
1/2"	7/8"
9/16"	1"
19/32"	

**JCM2212 / JCP2212**  
**Juego de Copas 22 pcs**

**Medida**  
**In - mm**



**Medida: 12 PTZ C/ 1/2"**

Cuadrante

**1/2"**

Juego de 22  
 piezas

**22**  
**PCS**

Cumple con la  
 norma:

**ANSI**

Pulido espejo para  
 fácil limpieza

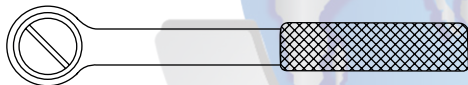

Ratchet económico 1/2"  
 x 1 pcs



Extensión de 1/2" x 5" y 10"  
 x 2 pcs

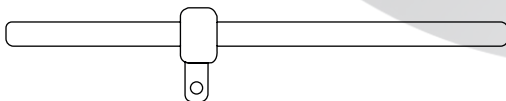

Mango Corredizo P/copa 1/2" x 10" x 1 pcs

Medida: 12 PTZ C/ 1/2"		5/16"	11/16"	8 mm	17 mm
		11/32"	23/32"	9 mm	18 mm
		3/8"	3/4"	10 mm	19 mm
		7/16"	13/16"	11 mm	21 mm
		15/32"	7/8"	12 mm	22 mm
Medida: 6 PTZ C/ 1/2"		1/2"	15/16"	13 mm	24 mm
		9/16"	1-1/16"	14 mm	27 mm
		19/32"	1-3/16"	15 mm	30 mm
		5/8"	1-1/4"	16 mm	32 mm

x 18 pcs

**JCM2638 / JCP2638**  
**Juego de Copas 26 pcs**

**Medida**  
**In - mm**



**Medida: 12 y 6 PTZ C/ 3/8"**

Cuadrante

**3/8"**

Juego de 26  
 piezas

**26**  
**PCS**

Cumple con la  
 norma:

**ANSI**

Pulido espejo para  
 fácil limpieza

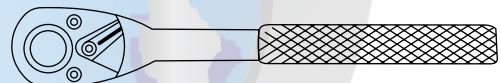

Ratchet rugoso 3/8" x 1 pcs



Extensión de 3/8" x 2", 3" y 6" x 3 pcs



Copa para bujía  
 5/8" (16mm) y 13/16"  
 (21mm) x 2 pcs

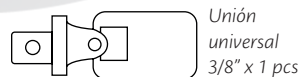

Unión  
 universal  
 3/8" x 1 pcs



Adaptador para copa  
 1/2" F \* 3/8" M  
 x 1 pcs

Medida: 12 PTZ C/ 3/8"		1/4"	5/8"	6 mm	15 mm
		9/32"	19/32"	7 mm	16 mm
		5/16"	11/16"	8 mm	17 mm
		11/32"	23/32"	9 mm	18 mm
		3/8"	3/4"	10 mm	19 mm
Medida: 6 PTZ C/ 3/8"		7/16"	25/32"	11 mm	20 mm
		15/32"	13/16"	12 mm	21 mm
		1/2"	7/8"	13 mm	22 mm
		9/16"	15/16"	14 mm	24 mm

x 18 pcs

**JCM2812**  
**Juego de Copas 28 pcs**

**Medida**  
**mm**



Cuadrante

**1/2"**

Cumple con la norma:

**ANSI**

Juego de 28 piezas

**28 PCS**

Pulido espejo para fácil limpieza



**Medida: 12 PTZ C/ 1/2"**



Ratchet económico de 1/2" x 1pcs



Volvedor berbiqui 10" x 1 pcs

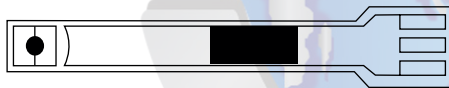

Extensión 5" y 10" x 2 pcs



Unión universal 1/2" x 1 pcs

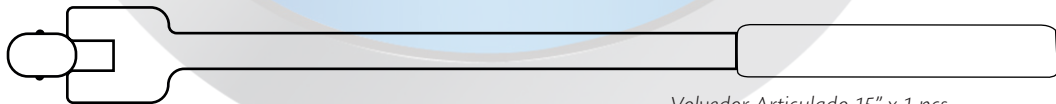

Volvedor Articulado 15" x 1 pcs

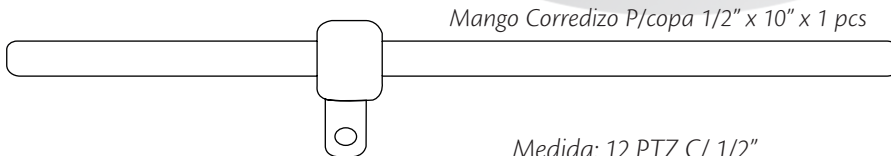

Mango Corredizo P/copa 1/2" x 10" x 1 pcs

Medida: 12 PTZ C/ 1/2"

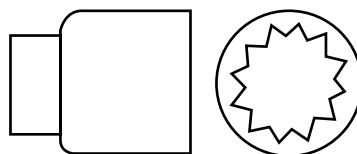

10 mm, 11 mm, 12 mm, 13 mm, 14 mm,  
 15 mm, 16 mm, 17 mm, 18 mm, 19 mm,  
 20 mm, 21 mm, 22 mm, 23 mm, 24 mm,  
 25 mm, 26 mm, 27 mm, 28 mm, 30 mm,  
 32 mm.  
 x 21 pcs

**JCM3212 / JCP3212**  
**Juego de Copas 32 pcs**

**Medida**  
**In - mm**



Cuadrante



Cumple con la norma:



Juego de 32 piezas



Pulido espejo para fácil limpieza



Ratchet tipo pera encauchado de 1/2"

x 1 pcs



Copa para bujía 13/16" (21)

x 1 pcs



Copa para bujía 5/8" (16)

x 1 pcs

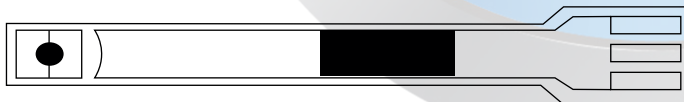

Extensión de 1/2" x 5" y 10"

x 2 pcs



Unión universal

1/2" x 1 pcs

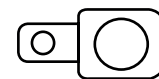

Adaptador para extensión

3/8" F \* 1/2" M

x 1 pcs

Medida: 12 PTZ C/ 1/2"

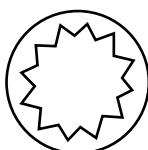
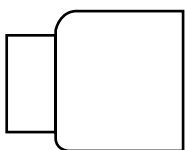

3/8"	10 mm
15/32"	12 mm
9/16"	14 mm
23/32"	15 mm
11/16"	17 mm
3/4"	19 mm

x 6 pcs

Medida: 6 PTZ C/ 1/2"

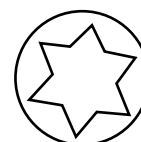
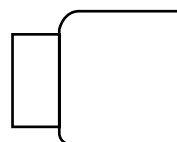

5/16"	26/32"	8 mm	18 mm
11/32"	3/4"	9 mm	19 mm
3/8"	23/32"	10 mm	20 mm
7/16"	13/16"	11 mm	21 mm
15/32"	7/8"	12 mm	22 mm
1/2"	15/16"	13 mm	24 mm
9/16"	1-1/16"	14 mm	27 mm
19/32"	1-3/16"	15 mm	30 mm
5/8"	1-1/4"	16 mm	32 mm
11/16"		17 mm	

x 19 pcs

**JCP3812 / JCM3812**  
**Juego de Copas 38 pcs**

**Medida**  
**In - mm**



Cuadrante

**1/2"**

Juego de 38  
 piezas

**38  
 PCS**

Cumple con la  
 norma:

**ANSI**

Pulido espejo para  
 fácil limpieza



Ratchet tipo pera encauchado de 1/2"

x 1 pcs



Palanca 1/2" x 12"  
 x 1 pcs



Extensión de 1/2" / 10"  
 x 1 pcs



Adaptador para  
 copa x 1 pcs  
 3/8" F \* 1/2" M



Unión  
 universal  
 1/2" x 1 pcs

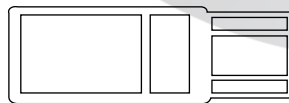

Copa para  
 bujía 13/16"  
 (21) x 1 pcs



Copa para bujía 5/8" (16)  
 x 1 pcs

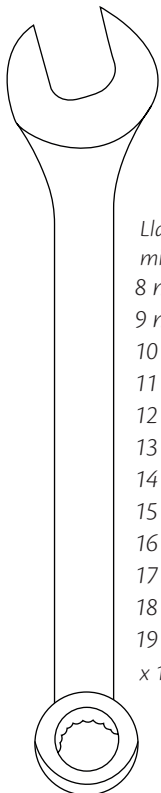

Llave  
 mixta  
 8 mm  
 9 mm  
 10 mm  
 11 mm  
 12 mm  
 13 mm  
 14 mm  
 15 mm  
 16 mm  
 17 mm  
 18 mm  
 19 mm  
 x 12 pcs

Medida: 12 PTZ C/ 1/2"

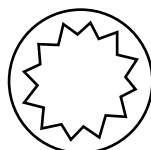
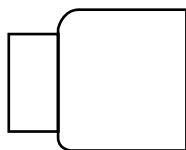

Medida: 6 PTZ C/ 1/2"

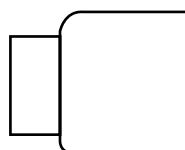

x 19 pcs

5/16"	26/32"	8 mm	18 mm
11/32"	3/4"	9 mm	19 mm
3/8"	23/32"	10 mm	20 mm
7/16"	13/16"	11 mm	21 mm
15/32"	7/8"	12 mm	22 mm
1/2"	15/16"	13 mm	24 mm
9/16"	1-1/16"	14 mm	27 mm
19/32"	1-3/16"	15 mm	30 mm
5/8"	1-1/4"	16 mm	32 mm
11/16"		17 mm	

### RTP Ratchet Tipo Pera Encauchetado

Medida  
In

Pulido espejo para fácil limpieza



Cuadrante

1/4"

3/8"

1/2"

Cód.	Medida	Uni E
RTP14	1/4"	1
RTP38	3/8"	1
RTP12	1/2"	1

### VART Volvedor Articulado

Medida  
In

Pulido espejo para fácil limpieza



Cuadrante

3/8"

1/2"

Cód.	Medida	Uni E
VART3810	3/8"X10"	1
VART3815	3/8"X15"	1
VART1210	1/2"X10"	1
VART1215	1/2"X15"	1

### RTE Ratchet Económico

Medida  
In

Pulido espejo para fácil limpieza



Cuadrante

1/4"

3/8"

1/2"

Cód.	Medida	Uni E
RTE14	1/4"	1
RTE38	3/8"	1
RTE12	1/2"	1

### RTPR Ratchet rugoso

Medida  
In

Pulido espejo para fácil limpieza



Cuadrante

1/4"

3/8"

1/2"

Cód.	Medida	Uni E
RTPR12	1/2"	1
RTPR14	1/4"	1
RTPR38	3/8"	1

### ALS Alicata Electricista CRV / Prof

Medida  
In

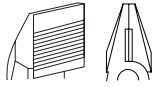

Alicata punta plana,  
Mordazas con  
moletado horizontal para  
mejor agarre.  
Hechas en Cromo Vanadio



Cód.	Medida	Uni E
ALS6	6"	60
ALS7	7"	60
ALS8	8"	60

### PZS Pinza Punta CRV / PROF

Medida  
In

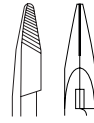

Pinza punta plana,  
Mordazas con  
moletado horizontal para  
mejor agarre.  
Hechas en Cromo Vanadio



Cód.	Medida	Uni E
PZS6	6"	60
PZS7	7"	60
PZS8	8"	60

### PZCS Pinza Punta Curva CRV / PROF

Medida  
In

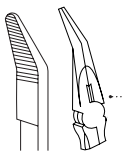

Pinza punta curva,  
Mordazas con  
moletado horizontal  
para mejor agarre.  
Hechas en Cromo  
Vanadio



Cód.	Medida	Uni E
PZCS7	7"	60
PZCS8	8"	60

### CFS Cortafrio CRV / PROF

Medida  
In



Cortafrio punta  
estandar  
Hecho en cromo  
vanadio



Cód.	Medida	Uni E
CFS6	6"	60
CFS7	7"	60
CFS8	8"	60

**TARS10**  
TIJERA AVIACIÓN RECTA

Medida  
In



Cód.	Medida	Uni E
TARS10	10"	1

**TADS10**  
TIJERA AVIACIÓN DERECHA

Medida  
In



Cód.	Medida	Uni E
TADS10	10"	1

**TAIS10**  
TIJERA AVIACIÓN IZQUIERDA

Medida  
In



Cód.	Medida	Uni E
TAIS10	10"	1

**LTS**  
LLAVE BRISTOL CORTA CR VAN

Medida  
In



6 puntas



Código	Descripción	Unidad E.	Código	Descripción	Unidad E.
LHPS116	1/16"	1	LHMS15	1.5mm	1
LHPS332	3/32"	1	LHMS2	2.0mm	1
LHPS18	1/8"	1	LHMS25	2.5mm	1
LHPS532	5/32"	1	LHMS3	3.0mm	1
LHPS316	3/16"	1	LHMS4	4.0mm	1
LHPS14	1/4"	1	LHMS5	5.0mm	1
LHPS38	3/8"	1	LHMS6	6.0mm	1
LHPS12	1/2"	1	LHMS8	8.0mm	1
LHPS964	9/64"	1	LHMS10	10mm	1
LHPS564	5/64"	1	LHMS12	12mm	1
LHPS764	7/64"	1	/	/	/

**LTS**  
LLAVE TIPO TORX CORTA

Medida  
In



6 puntas



Código	Descripción	Unidad E.
LTS7	T-7	1
LTS8	T-8	1
LTS9	T-9	1
LTS10	T-10	1
LTS15	T-15	1
LTS20	T-20	1
LTS25	T-25	1
LTS27	T-27	1
LTS30	T-30	1
LTS40	T-40	1
LTS45	T-45	1
LTS50	T-50	1
LTS55	T-55	1



### JHS8P / JHSP8P JUEGO LLAVES BRISTOL CORTAS

Medida  
In / mm

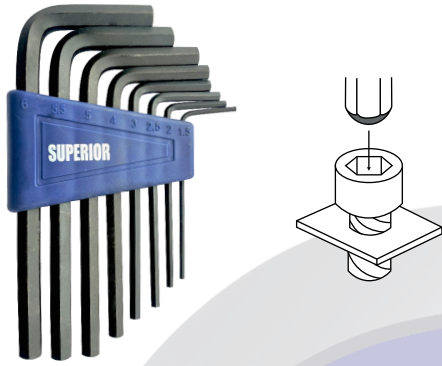

Código	Medida	Uni. E	Código	Medida	Uni. E
JHS8P	1.5 mm	1	JHSP8P	1/16"	1
	2 mm	1		5/64"	1
	2.5 mm	1		3/32"	1
	3 mm	1		1/8"	1
	4 mm	1		5/32"	1
	5 mm	1		3/16"	1
	5.5 mm	1		7/32"	1
	6 mm	1		1/4"	1

### JHBS8P JUEGO LLAVES BRISTOL CORTAS

Medida  
mm



Código	Medida	Uni. E
JHBS8P	1.5 mm	1
	2 mm	1
	2.5 mm	1
	3 mm	1
	4 mm	1
	5 mm	1
	5.5 mm	1
	6 mm	1

### JHSP10P / JHS10P JUEGO LLAVES BRISTOL LARGAS 10PCS

Medida  
In / mm

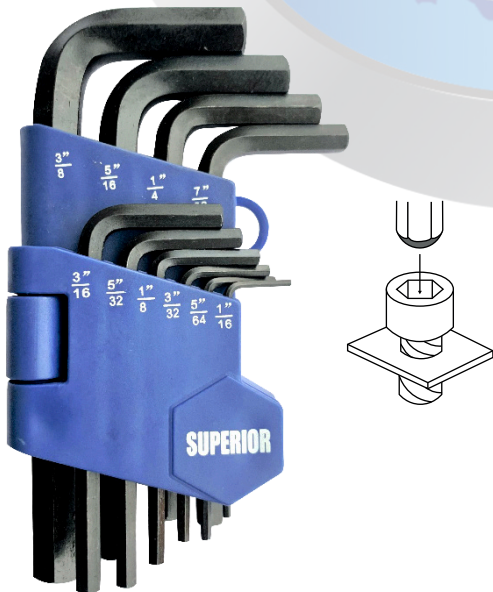

Código	Medida	Uni. E	Código	Medida	Uni. E
JHSP10P	1.5 mm	1	JHS10P	1/16"	1
	2 mm	1		5/64"	1
	2.5 mm	1		3/32"	1
	3 mm	1		1/8"	1
	4 mm	1		5/32"	1
	5 mm	1		3/16"	1
	5.5 mm	1		7/32"	1
	6 mm	1		1/4"	1
	8 mm	1		5/16"	1
	10 mm	1		3/8"	1

**JTS7P**  
JUEGO LLAVES TORX CORTAS 7PCS

Medida  
TORX



6 puntas  
Fácil acople

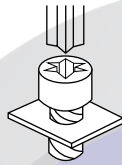

Código	Medida	Uni. E
JTS7P	T10	1
	T15	1
	T20	1
	T25	1
	T27	1
	T30	1
	T40	1

**TZAS8**  
TENAZA CR VAN

Medida  
In



Código	Medida	Uni E
TZAS7	7"	1
TZAS8	8"	1

**CZSE7834**  
CRUCETA ESCUALIZABLE

Medida  
In / mm

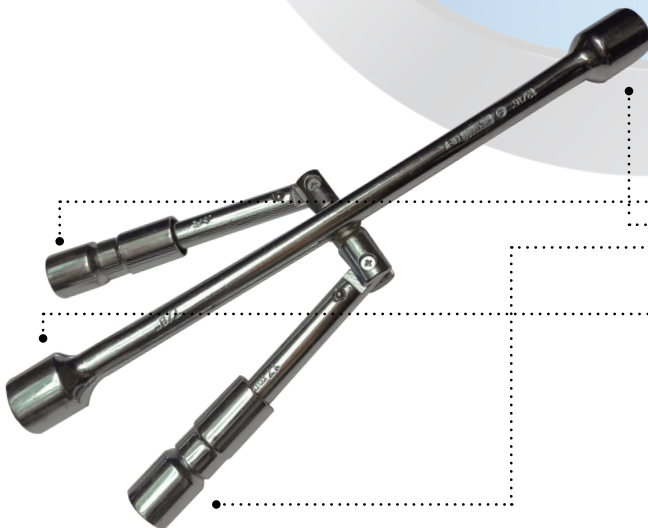

Cód.	Medida	Uni E
CZSE7834	7/8" X 3/4" X 13/16" X 17 mm	18

### LDC Copa Artillera CR Van

Medida  
mm



  
Pulido espejo para  
fácil limpieza

**Cód.** **Medida** **Uni E**

LDC2224	22mm X 24mm	12
LDC2227	22mm X 27mm	12
LDC2427	24mm X 27mm	12
LDC2730	27mm X 30mm	12
LDC2732	27mm X 32mm	12
LDC3032	30mm X 32mm	12
LDC3033	30mm X 33mm	12
LDC2138	21mm X 38mm	8
LDC2141	21mm X 41mm	8

### LLC Copa de Palanca CR Van

Medida  
mm



  
Pulido espejo para  
fácil limpieza

**Cód.** **Medida** **Uni E**

LLC17	17mm	40
LLC19	19mm	40
LLC21	21mm	40
LLC23	23mm	40
LLC24	24mm	36

### CZ1914 Cruceta CR Van

Medida  
In - mm



  
Pulido espejo para  
fácil limpieza

**Cód.** **Medida** **Uni E**

CZ1914	13/16" x 11/16" x 17MM x 19MM x 14"	20
--------	--	----

### MBS Martillo bola Fibra de Vidrio

Peso  
Lb



**Cód** **Medida** **Uni. E**

MBS12	1/2 Lb	60
MBS34	3/4 Lb	48
MBS1	1 Lb	24
MBS112	1 1/2 Lb	24
MBS2	2 Lb	12
MBS212	2 1/2 Lb	12
MBS3	3 Lb	12

**MUS**  
**Martillo uña fibra de Vidrio**

**Medida**  
**mm**



Cód	Medida	Un. E.
MUS21	21mm	24
MUS23	23mm	24
MUS25	25mm	24
MUS27	27mm	24
MUS29	29mm	24

**MS**  
**Martillo Caucho Fibra de Vidrio**

**Medida**  
**Oz**



Cód.	Medida	Uni. E.
MS8OZ	8 OZ	60
MS12OZ	12 OZ	24
MS16OZ	16 OZ	24
MS24OZ	24 OZ	24
MS32OZ	32 OZ	24

**MCS**  
**Martillo Tipo Cantero Fibra de Vidrio**

**Medida**  
**Gr**



Cód	Descripción	Un. E.
MCS3	300 Gr	60
MCS4	400 Gr	60

**MS**  
**Maceta con Cabo Fibra de Vidrio**

**Medida**  
**Lb**



Cód.	Medida	Uni. E.	Cód.	Medida	Uni. E.
MS2L	2 Lb	12	MS10L	10 Lb	2
MS3L	3 Lb	12	MS12L	12 Lb	2
MS4L	4 Lb	12	MS14L	14 Lb	2
MS6L	6 Lb	4	MS16L	16 Lb	2
MS8L	8 Lb	4	MS18L	18 Lb	2

**FLCR**  
Flexómetro Cromado

Medida  
M

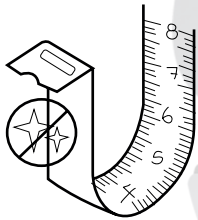

Cinta con terminado mate

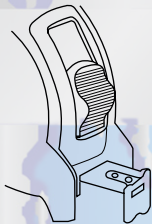

Freno de posicionamiento de la cinta

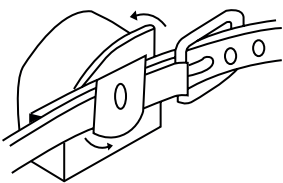

Gancho de soporte para ubicar en el cinturón

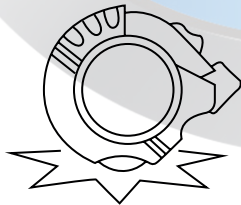

Resistencia a impactos leves

**FLTR**  
Flexómetro Transparente

Medida  
M

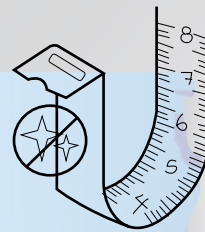

Cinta con terminado mate

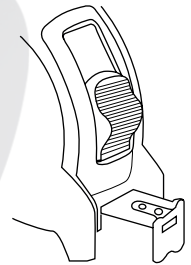

Freno de posicionamiento de la cinta

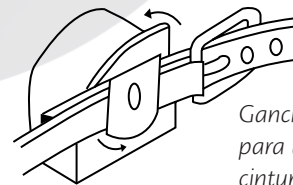

Gancho de soporte para ubicar en el cinturón

**CÓDIGO METROS ANCHO DE CINTA**

FLCR3MT	3M	16 mm
FLCR5MT	5M	25 mm
FLCR8MT	8M	25 mm

**CÓDIGO METROS ANCHO DE CINTA**

FLTR3MT	3M	16 mm
FLTR5MT	5M	25 mm
FLTR8MT	8M	25 mm

**FLENC**  
Flexómetro encauchetado

Medida  
M

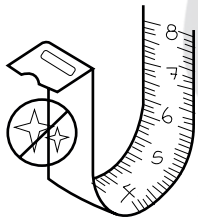

Cinta con terminado mate

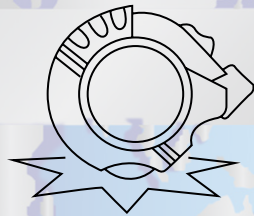

Carcasa de plástico con recubrimiento en caucho resistente a impactos

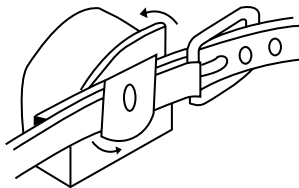

Gancho de soporte para ubicar en el cinturón

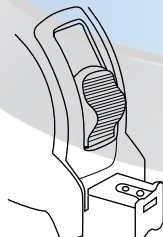

Freno de posicionamiento de la cinta

**FLECO**  
FLEXÓMETRO

Medida  
M

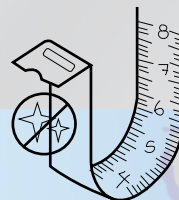

Cinta con terminado mate

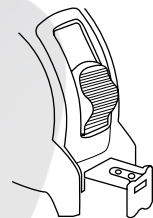

Freno de posicionamiento de la cinta

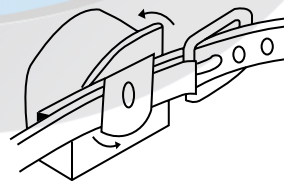

Gancho de soporte para ubicar en el cinturón

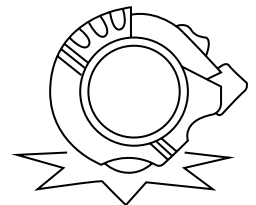

Resistencia a impactos leves

**CÓDIGO METROS ANCHO DE CINTA**

FLENC3MT	3M	16 mm
FLENC5MT	5M	25 mm
FLENC8MT	8M	25 mm

**CÓDIGO METROS ANCHO DE CINTA**

FLECO5MT	5M	19 mm
FLECO8MT	8M	25 mm

**MB**  
**Martillo Tipo Bola Mango Madera**

Medida  
Lb



Cód	Medida	Uni. E.
MB12	1/2 Lb	60
MB34	3/4 Lb	48
MB1	1 Lb	24
MB112	1 1/2 Lb	24
MB2	2 Lb	12
MB212	2 1/2 Lb	12
MB3	3 Lb	12

**MU**  
**Martillo de Uña Mango Madera**

Medida  
Lb



Cód.	Medida	Uni.E.
MU21	21 mm	24
MU23	23 mm	24
MU25	25 mm	24
MU27	27 mm	24
MU29	29 mm	24

**M**  
**Martillo Caucho Mango Madera**

Medida  
Oz



Cód.	Medida	Uni. E.
M8OZ	8 OZ	60
M12OZ	12 OZ	24
M16OZ	16 OZ	24
M24OZ	24 OZ	24
M32OZ	32 OZ	24

**MC**  
**Martillo Tipo Cantero Mango Madera**

Medida  
Gr



Cód.	Medida	Uni E
MC3	300 Gr	60
MC4	400 Gr	60

**M3L**  
**Maceta Cabo Mango Madera**

**Medida**  
**Lb**



Cód.	Medida	Uni. E.	Cód.	Medida	Uni. E.
M3L	3 Lb	12	M12L	12 Lb	2
M4L	4 Lb	12	M14L	14 Lb	2
M6L	6 Lb	4	M16L	16 Lb	2
M8L	8 Lb	4	M18L	18 Lb	2
M10L	10 Lb	2	M20L	20 Lb	2

**LTK**  
**Llave de Tubo**

**Medida**  
**In**



Cód.	Medida	Uni E
LTK10	10"	50
LTK12	12"	40
LTK14	14"	30
LTK18	18"	20
LTK24	24"	5

**HSK**  
**Hombre solo**

**Medida**  
**In**



Cód.	Medida	Uni E
HSK10	10"	1
HSK7	7"	1

**TZA**  
**Tenaza**

**Medida**  
**In**



Cód.	Medida	Uni E
TZA6	6"	10
TZA8	8"	10

**PZEX10**  
**Alicate Pico de Loro**

**Medida**  
**In**



Cód.	Medida	Uni E
PZEX10	10"	10



**ALDK10**  
**Alicate Diablo**

Medida In



Cód.	Medida	Uni E
ALDK10	10"	10

**PZK**  
**Pinza Punta**

Medida In



Alicate punta plana,  
Mordazas con moleteado  
horizontal para mejor agarre.  
Hechas en acero carbón

Cód.	Medida	Uni E
PZK5	5"	80
PZK6	6"	60
PZK7	7"	60
PZK8	8"	10

**ALK**  
**Alicate electricista**

Medida In



Alicate punta plana,  
Mordazas con moleteado  
horizontal para mejor agarre.  
Hechas en acero carbón

Cód.	Medida	Uni E
ALK6	6"	60
ALK7	7"	60
ALK8	8"	60

**CFK**  
**Corta frio**

Medida In



Cód.	Medida	Uni E
CFK6	6"	10
CFK7	7"	10

**ALKEX**  
**Alicate para mecánico  
2 posiciones**

Medida In



Cód.	Medida	Uni E
ALKEX6	6"	10
ALKEX7	7"	10
ALKEX8	8"	10
ALKEX10	10"	60

**PCIK7**  
**Pinzas P/Pines Interno  
Curva**

Medida In

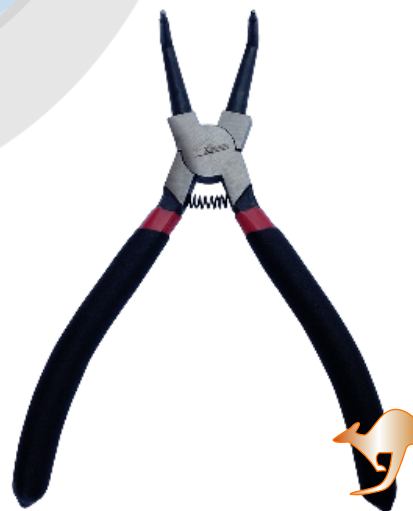

Cód.	Medida	Uni E
PCIK7	7"	60

**HTCK**  
**Hombre solo prensa en C**

Medida In



JUEGO DE ALICATES  
3 PIEZAS

Alicate 8"  
Pinza 6"  
corta fños 6"

Cód.	Medida	Unidad E.
JAK3P	3 PZS (6"-6"-8")	42

**HTCK**  
**Hombre solo prensa en C**

Medida In



Cód.	Medida	Unidad E.
HTCK11	11"	1

**PRIK7**  
**Pinzas P/Pines Interna Recta**

Medida In



Cód.	Medida	Uni E
PRIK7	7"	60

**PCEK7**  
**Pinzas P/Pines Externo Curva**

Medida In



Cód.	Medida	Uni E
PCEK7	7"	60

**PREK7**  
**Pinzas P/Pines Externo Recta**

Medida In



Cód.	Medida	Uni E
PREK7	7"	60

**LE**  
**Llave Expansiva Cromada**

**Medida**  
**In**



Cód.	Medida	Uni E
LE6	6"	10
LE8	8"	10
LE10	10"	10
LE12	12"	5
LE15	15"	5
LE18	18"	5
LE24	24"	5

**MTS**  
**Mandril para Taladro con llave**

**Medida**  
**In**



Cód.	Medida	Uni E
MTS1258	1/2 x 5/8	10
MTS3812	3/8 x 1/2	10
MTS5858	5/8 x 5/8	10

**CZM**  
**Cizalla Manual**

**Medida**  
**In**



Cód.	Medida	Uni E
CZM8	8"	1
CZM12	12"	1
CZM14	14"	1
CZM18	18"	1
CZM30	30"	1
CZM36	36"	1
CZM42	42"	1

**LTK**  
**Llave de Tubo**

**Medida**  
**In**



Cód.	Medida	Uni E
LTK10	10"	50
LTK12	12"	40
LTK14	14"	30
LTK18	18"	20
LTK24	24"	5
LTK36	36"	5

## LB Llave de Bujía

Medida  
mm



Cód.	Medida	Uni E
LB67	6x7 mm	10
LB89	8x9mm	10
LB1011	10x11 mm	10
LB1213	12x13 mm	10
LB1415	14x15 mm	10
LB1617	16x17 mm	10
LB1819	18x19 mm	10
LB2022	20x22 mm	10
LB2123	21x23 mm	10
LB2528	25x28 mm	10
LB2426	24x26 mm	10

## EMK Escuadra Metálica

Medida  
In



Cód.	Medida	Uni E
EMK8	8"	60
EMK9	9"	60
EMK10	10"	60
EMK10	12"	48

## ABG Abecedario de Golpe

Medida  
mm



Cód.	Medida	Uni E
ABGS3	3 mm	60
ABGS4	4 mm	50
ABGS5	5 mm	20
ABGS6	6 mm	10
ABGS8	8 mm	10
ABGS10	10 mm	5
ABGS12	12 mm	4

## NUGS Numerador de Golpe

Medida  
mm



Cód.	Medida	Uni E
NUGS3	3 mm	250
NUGS4	4 mm	200
NUGS5	5 mm	50
NUGS6	6 mm	30
NUGS8	8 mm	25
NUGS10	10 mm	20
NUGS12	12 mm	10

**EXD**  
**Extractor de rodamientos**  
**Doble Agarre**

Medida  
In



Cód.	Medida	Uni E
EXD3	3"	40
EXD4	4"	20
EXD6	6"	16
EXD8	8"	12
EXD10	10"	8

**EXT**  
**Extractor de rodamientos**  
**Tres brazos**

Medida  
In



Cód.	Medida	Uni E
EXT3	3"	40
EXT4	4"	20
EXT6	6"	16
EXT8	8"	12
EXT10	10"	8

**ACS**  
**ADAPTADOR SUPERIOR P/COPA CR VAN**

Medida  
In

Código	Descripción	Unidad E.
ACS1234	M1/2" x H3/4"	1
ACS1238	M1/2" x H3/8"	1
ACS1438	M1/4" x H3/8"	1
ACS3812	M3/8" x H1/2"	1
ACS3814	M3/8" x H1/4"	1



# CATÁLOGO TÉCNICO HERRAMIENTA MANUAL



## **Mosquera, Cundinamarca Colombia**

Avenida troncal de occidente # 18-76  
lote 7 manzana F bodega 8  
893 98 00

## **Bogotá, Colombia**

Calle 15 No. 19 A - 01  
(57 1) 351 55 10

## **Barranquilla - Colombia**

Calle 53 No. 43-92 Bg 1 y 2 Barrio Boston  
(57 5) 305 98 60

Importadora Superior



Importadora Superior\_sas



Importadorasup1



+57 304 588 19 42



WWW.IMPORTADORASUPERIOR.COM

